

MODÜLER İKİZ KİLİTLEME VALFLERİ MODULAR PILOT CHECK VALVES MPC - 02



TEKNİK ÖZELLİKLER / TECHNICAL DATA

MAKSİMUM ÇALIŞMA BASINCI
MAX. OPERATING PRESSURE:
250 KGF/CM² (3600 PSI)

MAKSİMUM DEBİ / MAX. FLOW:
40 LPM (10.6 GPM)

AÇMA BASINCI / CRACKING PRESSURE:
5 KGS (70PSI)

AĞIRLIK / WEIGHT:
1.3 KGS

SEMBOLLER / SYMBOLS



MPC-02A

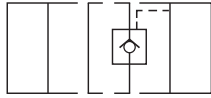

MPC-02B

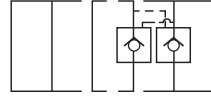

MPC-02W

SİPARİŞ KODU / ORDERING CODE

MPC -- 02 -- A -- 50

DİZAYN NUMARASI / DESIGN NUMBER

İŞ YAPACAK DELİKLER / FUNCTION PORT

A: A DELİĞİ / A PORT

B: B DELİĞİ / B PORT

W: A ve B DELİKLERİ / A&B PORTS

DELİK ÖLÇÜSÜ / PORT SIZE

02: 1/4"

PILOT KUMANDALI ÇEK VALFLER

PILOT CHECK VALVES

MPC - 02 SERİLERİ / MPC -02 SERIES

ÇALIŞMA EĞRİLERİ / PERFORMANCE CURVES

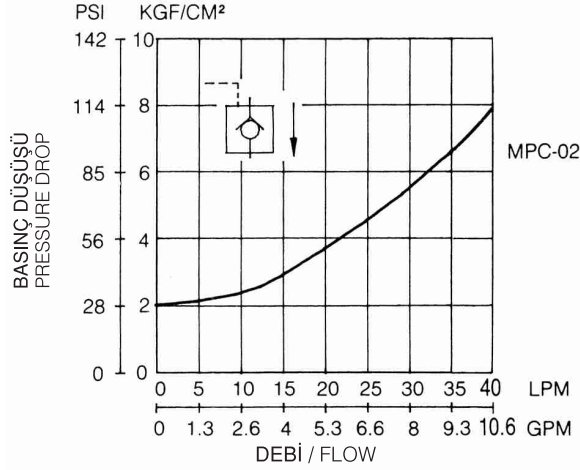
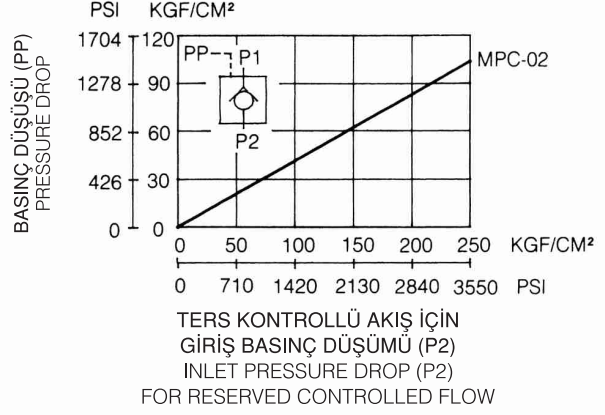
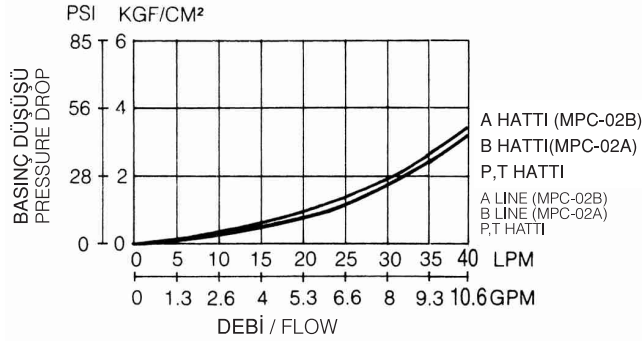
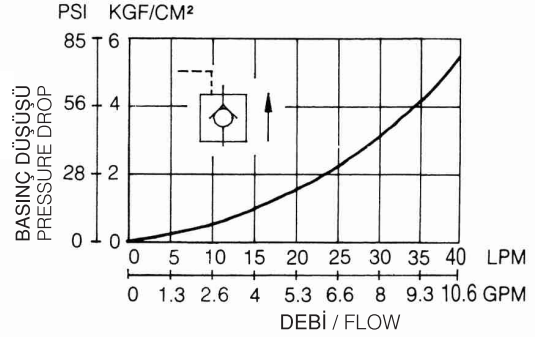
YAĞ ÇALIŞMA ÖLÇÜSÜ V= 35 CST VE T= 50°C
MIN. PILOT PRESSURE V= 35 CST VE T= 50°CSERBEST AKIŞ İÇİN BASINÇ DÜŞÜŞÜ
PRESSURE DROP FOR FREE FLOWMİNİMUM PİLOT BASINCI
MIN. PILOT PRESSURETERS KONTROLLÜ AKIŞ İÇİN
GİRİŞ BASINÇ DÜŞÜMÜ (P2)
INLET PRESSURE DROP (P2)
FOR RESERVED CONTROLLED FLOWBASINÇ DÜŞÜŞÜ
PRESSURE DROPTERS AKIŞ KONTROLÜNDE
BASINÇ DÜŞÜMÜ
PRESSURE DROP FOR RESERVE CONTROLLED FLOW.

ÖLÇÜLER / DIMENSIONS

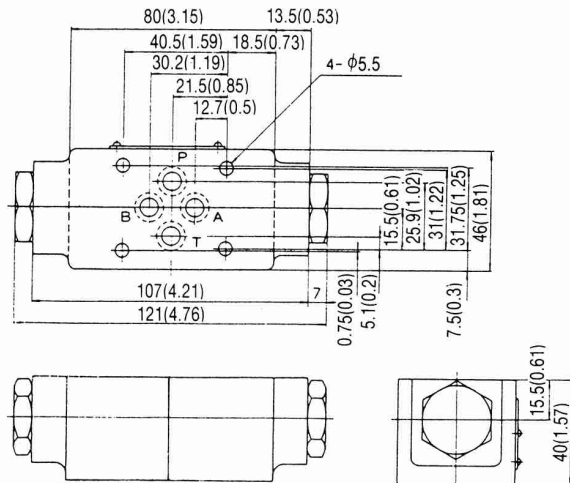

BİRİM / UNIT: MM(INCH)