

KMV Serisi Çekmeli Valfler (3/2 - 5/2) / KMV Series Knob Push - Pull Valves (3/2 - 5/2)

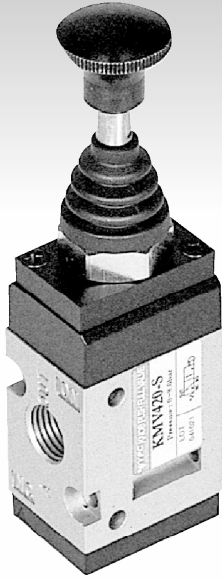

Sembol / Symbol

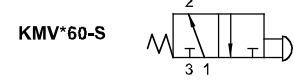
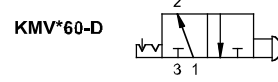
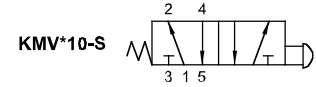
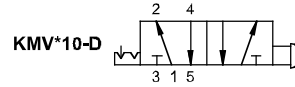

Akış Diyagramı / Flow Chart

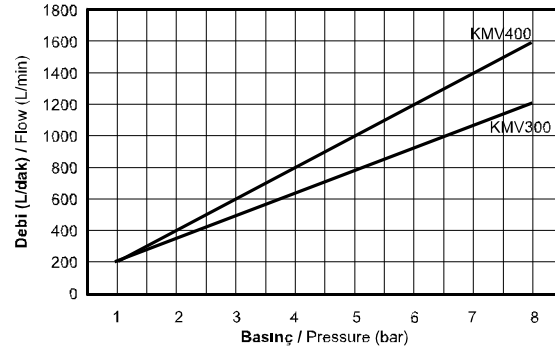

Özellikler / Specification

Model / Model	KMV300	KMV400
Akışkan / Fluid	40µ filtrelenmiş hava / Air (to be filtered by 40µ filter element)	
Çalışma Tipi / Operating	5/2	5/2 , 3/2
Bağlantı Ölçüsü / Port Size	1/8"	1/4"
Basınç Aralığı / Pressure Range	0~8.0 bar / 0~0.8MPa / 0~114Psi	
Kesit Alan / Sectional Area (mm ²)	13.5	18.0
Sıcaklık / Temperature	5 ~ 60°C	
Yağlama / Lubrication	Gerektirmez / Not Required (ISO VG32)	

Sipariş Kodu / Ordering Code

KMV3	1	0	S	P
Model Model	Fonksiyon Function	Diş Tipi Thread Type	Geri Dönüş Yöntemi / Return Method	Manuel Kontrol Manuel Operator
KMV3: 1/8" Bağlantı Deliği Port	1: 5/2 Yay Dönüslü 5/2 Spring Return	0: G	S: Kol-Yay / Push-Spring D: Kol-Kol / Push-Push DA: Kol-Hava / Push-Air	P: Oturtma Plakası Standing Plate
KMV4: 1/4" Bağlantı Deliği Port	6: 3/2 Yay Dönüslü NK 3/2 Spring Return NO			

KMV Serisi Çekmeli Valfler (3/2 - 5/2) / KMV Series Knob Push - Pull Valves (3/2 - 5/2)

Teknik Çizimler / Technical Drawings

KMV300

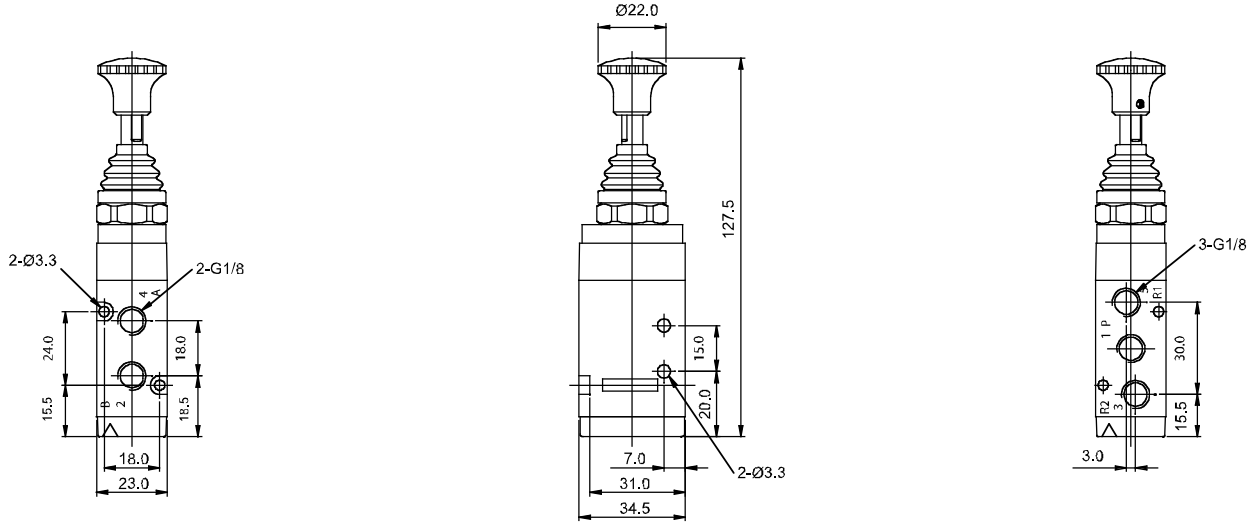

KMV400

